

Survey on ITS-G5 CAM statistics

CAR 2 CAR Communication Consortium



CAR 2 CAR
COMMUNICATION CONSORTIUM

About the C2C-CC

Enhancing road safety and traffic efficiency by means of Cooperative Intelligent Transport Systems and Services (C-ITS) is the dedicated goal of the CAR 2 CAR Communication Consortium. The industrial driven, non-commercial association was founded in 2002 by vehicle manufacturers affiliated with the idea of cooperative road traffic based on Vehicle-to-Vehicle Communications (V2V) and supported by Vehicle-to-Infrastructure Communications (V2I). Today, the Consortium comprises 88 members, with 18 vehicle manufacturers, 39 equipment suppliers and 31 research organisations.

Over the years, the CAR 2 CAR Communication Consortium has evolved to be one of the key players in preparing the initial deployment of C-ITS in Europe and the subsequent innovation phases. CAR 2 CAR members focus on wireless V2V communication applications based on ITS-G5 and concentrate all efforts on creating standards to ensure the interoperability of cooperative systems, spanning all vehicle classes across borders and brands. As a key contributor, the CAR 2 CAR Communication Consortium works in close cooperation with the European and international standardisation organisations such as ETSI and CEN.

Disclaimer

The present document has been developed within the CAR 2 CAR Communication Consortium and might be further elaborated within the CAR 2 CAR Communication Consortium. The CAR 2 CAR Communication Consortium and its members accept no liability for any use of this document and other documents from the CAR 2 CAR Communication Consortium for implementation. CAR 2 CAR Communication Consortium documents should be obtained directly from the CAR 2 CAR Communication Consortium.

Copyright Notification: No part may be reproduced except as authorized by written permission. The copyright and the foregoing restriction extend to reproduction in all media. © 2018, CAR 2 CAR Communication Consortium.

Document information

Number:	TR2052	Version:	1.0.1	Date:	2018 – 12 – 10
Title:	Survey on CAM statistics			Document Type:	Technical Report
Release:	14 December 2018				
Release Status:	Released for public sharing				
Status:	final				

Author:

Company /Institute	Author	Chapter
NXP	Vincent Martinez	
FBConsulting	Friedbert Berens	

Approval:

Function	Name, Company	Date	Signature
release	Steering Committee	14 Dec 18	

Outstanding Issues

Issue	Author	Chapter

Content

About the C2C-CC	1
Disclaimer	1
Document information	2
Changes since last version.....	3
Content	4
List of tables	4
List of figures.....	5
1 Introduction	7
1.1 Abstract.....	7
1.2 Executive summary.....	8
2 CAM structure and generation rules	9
2.1 CAM structure overview	9
2.2 CAM generation algorithm.....	10
2.2.1 Example with triggering based on change of position	12
2.3 ITS-G5 stack: asynchronous messages	13
3 Theoretical CAM sizes variability.....	14
3.1 Optional containers	14
3.2 Signatures and certificates	14
3.3 Number of pathHistory	15
4 Drive tests and traces captured.....	16
5 Methodology.....	18
6 Results analysis	19
6.1 CAM sizes: variations versus time.....	19
6.2 CAM sizes: histograms distribution view.....	20
6.3 CAM: percentage of messages with certificates	21
6.4 CAM sizes: min, max and average statistics	22
6.5 CAM sizes: CDF distributions.....	22
6.6 CAM sizes: pathHistory detailed statistics	23
6.7 CAM time-intervals: variations vs time.....	25
6.8 CAM time-intervals: histograms distribution view.....	27
6.9 CAM time-intervals delta: histograms distribution view	29
6.10 CAM: duty cycles results	30
7 Conclusions.....	32
8 Appendix 1 – References	33
8.1 List of abbreviations	33
8.2 Related documents	34
8.3 CAM size histograms for each test drive	35
8.4 Acknowledgments	35

List of tables

Table 1-1 Executive summary, CAM statistics key observations	8
Table 2-1 ITS station speed, equivalent time-intervals & transmit rate.....	12
Table 2-2 AIFS and CW sizes for 802.11p broadcast messages	13
Table 4-1 Traces collected for the CAM statistics survey.....	16
Table 6-1 Percentage of message with certificates per test-drive	21
Table 6-2 Key CAM statistics for each test drive.....	22
Table 6-3 Number of pathHistory entries per test-drive	24

Table 6-4 ECC duty cycle requirements	30
Table 6-5 Measured duty cycles for each test drive	30

List of figures

Figure 2-1 Overview CAM Structure	10
Figure 2-2 CAM transmit rate depending on ITS station speed.....	12
Figure 2-3 ITS-G5 stack view	13
Figure 3-1 Example structure of a certificate (table A.2 of ETSI TS 103 097)	14
Figure 4-1 VW urban drive map.....	17
Figure 4-2 VW suburban drive map	17
Figure 4-3 VW highway drive map.....	17
Figure 4-4 Renault highway drive map	17
Figure 4-5 Renault suburban drive map	17
Figure 4-6 Renault urban drive map	17
Figure 5-1 Wireshark tool example	18
Figure 6-1 CAM size vs time: VW urban.....	19
Figure 6-2 CAM size vs time: VW suburban	19
Figure 6-3 CAM size vs time: VW highway	19
Figure 6-4 CAM size vs time: Renault urban	19
Figure 6-5 CAM size vs time: Renault suburban.....	19
Figure 6-6 CAM size vs time: Renault highway	19
Figure 6-7 CAM size vs time: VW highway – zoom	20
Figure 6-8 CAM size histogram: VW summary	21
Figure 6-9 CAM size histogram: Renault summary.....	21
Figure 6-10 CAM size CDF: VW summary	23
Figure 6-11 CAM size CDF: Renault summary	23
Figure 6-12 Study on correlation of pathHistory and speed	23
Figure 6-13 number of pathHistory entries for Renault drives	24
Figure 6-14 CAM time-interval: VW urban	25
Figure 6-15 CAM time-interval: VW suburban	25
Figure 6-16 CAM time-interval: VW highway	26
Figure 6-17 CAM time-interval: Renault urban.....	26
Figure 6-18 CAM time-interval: Renault suburban.....	26
Figure 6-19 CAM time-interval: Renault highway.....	26
Figure 6-20 CAM time-interval: VW highway, zoom.....	26
Figure 6-21 CAM time-interval: VW urban, zoom.....	27
Figure 6-22 CAM time-interval histogram: VW urban.....	28
Figure 6-23 CAM time-interval histogram: VW suburban	28
Figure 6-24 CAM time-interval histogram: VW highway.....	28
Figure 6-25 CAM time-interval histogram: Renault urban	28
Figure 6-26 CAM time-interval histogram: Renault suburban	28
Figure 6-27 CAM time-interval histogram: Renault highway	28
Figure 6-28 CAM time-interval delta: VW urban	29
Figure 6-29 CAM time-interval delta: VW suburban.....	29

Figure 6-30 CAM time-interval delta: VW highway.....	29
Figure 6-31 CAM time-interval delta: Renault urban	29
Figure 6-32 CAM time-interval delta: Renault suburban	29
Figure 6-33 CAM time-interval delta: Renault highway	29
Figure 6-34 CAM duty cycles: VW urban.....	31
Figure 6-35 CAM duty cycles: VW suburban	31
Figure 6-36 CAM duty cycles: VW highway	31
Figure 6-37 CAM duty cycles: Renault urban	31
Figure 6-38 CAM duty cycles: Renault suburban.....	31
Figure 6-39 CAM duty cycles: Renault highway	31
Figure 8-1 CAM size histogram: VW urban.....	35
Figure 8-2 CAM size histogram: VW suburban.....	35
Figure 8-3 CAM size histogram: VW highway.....	35
Figure 8-4 CAM size histogram: Renault urban	35
Figure 8-5 CAM size histogram: Renault suburban	35
Figure 8-6 CAM size histogram: Renault highway	35

1 Introduction

1.1 Abstract

This document provides a CAR 2 CAR Communication Consortium comprehensive analysis of ITS-G5 message traces collected in real test-drives in Europe in 2018. The current version focuses on the CAM messages sent by vehicles. Following versions are expected to include messages like DENMs, SPAT, MAP coming from vehicles and infrastructure. Following versions are expected to include messages like DENMs, SPAT, MAP coming from vehicles and infrastructure.

The measurement traces have been collected in standard traffic conditions and standard drives. These drives should be representative of most driving situations in Europe. In order to guarantee a representative panel, the measurements traces have been collected by different car makers (VW, Renault), in different locations, with different ITS-G5 hardware equipment from different vendors.

The traces have been analysed statistically, and typical distributions of some metrics such as CAM size and CAM time-interval are provided.

The document is organized in the following chapters:

- CAM structure and generation rules
- Theoretical CAM sizes variability
- Drive tests and traces captured
- Methodology
- Results analysis
 - CAM sizes: variations versus time
 - CAM sizes: histograms distribution view
 - Percentage of messages with certificates
 - CAM sizes: min, max and average statistic
 - CAM sizes: CDF distributions
 - CAM sizes: pathHistory detailed statistics
 - CAM time-intervals: variations vs time
 - CAM time-intervals: histograms distribution view
 - CAM time-intervals delta: histograms distribution view
 - CAM duty cycles
- Conclusions

This paper is applicable for short range direct based on ITS-G5 technology. The provided background information is as much exhaustive as possible and related to the ITS-G5 CAM type of messages. Complementary information is available in ETSI norms.

1.2 Executive summary

The study has led to some key observations, captured in the following table. They highlight the very diverse and non-persistent nature of the CAM messages, both from a size and a transmit rate perspective.

Table 1-1 Executive summary, CAM statistics key observations

Observation ID	Observation summary
Observation #1	CAM size keeps changing from one message to the next, for all the drives.
Observation #2	The set of possible CAM sizes is very diverse, for all test drives.
Observation #3	Significant differences in the upper part of the CAM distribution, per manufacturer or facilities layer profiles
Observation #4	Only between 25% and 35% of the messages do not contain certificates.
Observation #5	The average CAM sizes is typically around 350 Bytes
Observation #6	The approximate CAM size distributions can be observed: <ul style="list-style-type: none"> • Distribution starts around 190 Bytes • Typically, 30% of the messages are below 300 Bytes • Typically, more than 50% of the messages are above 350 Bytes • Typically, more than 30% of the messages are above 450 Bytes
Observation #7	Speed and number of pathHistory entries are heavily correlated.
Observation #8	In practice, the CAM time-interval very often changes from one message to the next, observed in all the drives.
Observation #9	The distribution of the CAM time-interval is very diverse, and heavily depend on the drive scenario.
Observation #10	The average values of the time-intervals vary between 0.33 and 0.47 seconds.
Observation #11	In average, roughly only 50% of the time-interval deltas is zero
Observation #12	The duty cycles are consistently measured between 0.10% and 0.13%, for all test drives.
Observation #13	The short-term (1-second) duty cycles peaks are measured between 0.26% and 0.41%.

2 CAM structure and generation rules

2.1 CAM structure overview

The wireless V2V (vehicle-to-vehicle) and V2I (vehicle-to-infrastructure) communication via Vehicular Ad-hoc Network will lead to a safer, more efficient and more comfortable future mobility. The CAM is the main message type transmitted by any ITS-Station (e.g. vehicle and infrastructure devices) to announce its presence and share its dynamic information. It has been estimated that it will represent around 70% the traffic load of such a system. The generation rules are specified in EN 302 637-2 [RD-1].

ETSI EN 302 637-2: “Cooperative Awareness Messages (CAMs) are messages exchanged in the ITS network between ITS-Ss to create and maintain awareness of each other and to support cooperative performance of vehicles using the road network. A CAM contains status and attribute information of the originating ITS-S. The content varies depending on the type of the ITS-S. For vehicle ITS-Ss the status information includes time, position, motion state, activated systems, etc. and the attribute information includes data about the dimensions, vehicle type and role in the road traffic, etc.”

The CAM can be seen as an adjustable container that can carry different types of information. CAM messages are transmitted between one to ten times per second. The dynamic transmission rate depends on the behaviour of the vehicle (i.e. speed, steering, and change of acceleration, special vehicle or special vehicle condition). The size of the message is not static. The CAM size depends on the presence of different containers which are only present when needed, as well as on the security content like signatures and certificates. As a result, the CAM size can vary between around 200 Bytes and up to 800 Bytes depending on the message content.

The CAM consists of a collection of data elements that are arranged in a hierarchical order:

- mandatory information i.e. a heading indicating the StationID (vehicle pseudo ID), then
- basic data like a timestamp and position,
- status data as a sub-set refreshed in high frequency mode (HF) that includes vehicle static and dynamic data like: speed, heading, acceleration and curvature,
- attribute data in low frequency refreshing mode, like vehicle role or category and some
- basic sensors,
- optional container relating to vehicle category details (public transport, rescue).
- Signature
- Certificate

For further information on the CAM, such as processing operations and purpose of the processing, more details can be found in [RD-2].

According to the traffic and driving pattern, the size of a CAM can be at the upper end of the scale for a significant time of several minutes to hours. An overview of a vehicle CAM structure is depicted in Figure 2-1.

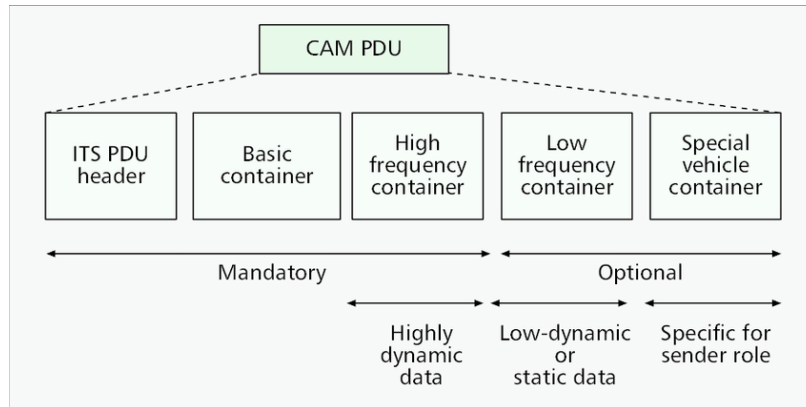

Figure 2-1 Overview CAM Structure

The dynamic, non-deterministic generation of the CAM has been introduced to reach the following significant benefits:

- It allows a very efficient use of the spectrum
- It helps avoiding congestion in the wireless channel maintaining a high level of information quality relevance for the surrounding vehicles and other road user devices.

Additionally, the minimization of the information to the strict required information supports GDPR requirements.

2.2 CAM generation algorithm

In the following the generation algorithm for CAM is depicted as defined in EN 302 672-2 [RD-1]. The rules specified here can be used as the basis for the calculation of the maximum CAM rate and the possible CAM sizes.

The CAM generation process considers the speed of the vehicle, the change in direction (heading) and the change in speed. Each of these parameters can trigger the generation of a CAM when reaching a specified threshold. These thresholds are defined in EN 302 672-2 [RD-1] as follow:

- Speed: A change in position by more than 4m
- Heading: A change of direction of equal or more than +/- 4°
- Change of speed: A change of speed equal to or larger than 0,5m/sec

If none of these conditions are fulfilled for 1 second or more a CAM is generated. The smallest time gap between two consecutive CAMs is set to 0,1 second. This leads to a maximum CAM frequency of 10 Hz and a minimum CAM frequency of 1 Hz.

This rule applies for the all CAM elements except for the Low Frequency and Special Containers. The Low Frequency container contains static information and therefore the transmission rate is limited to its purpose and generally not transmitted more often than twice a second. In general, special care has been taken to only send what strictly is required for ensuring safety, the special containers tailored to the specific purpose in general have a similar rate as the Low Frequency container based on their more static nature. The above time related requirements are detailed in the current ETSI specifications. For privacy and efficiency reasons the repetition rate of the CAMs is limited to the bare minimal, this in contrast with the approach in the USA where the BSM (read CAM) has a fixed rate of 10 Hz.

The dynamic non-deterministic generation of the CAM leads to a very efficient use of the spectrum and can help to avoid congestion in the wireless channel maintaining the required information deliverable to the surrounding vehicles and devices.

Algorithm 1: CAM message generation algorithm

Input: A new position read p , if any; a record of previous positions $pHist$; the last CAM message sent $lastCam$
Output: A new CAM message is sent and $lastCam$ is updated, if applicable; $pHist$ is updated with p , if applicable

```

1  while true do
2      time = System.getTime()
3      heading = calcHeading(pHist, p)
4      lastPos = lastPosition(pHist)
5      lastHist = pHist \ lastPos
6      lastHead = calcHeading(lastHist, lastPos)
7      speed = calcSpeed(pHist, p)
8      if p ≠ null then
9          lastSpeed = calcSpeed(lastHist, lastPos)
10         if distance(p, lastCam.pos) ≥ D_THRESHOLD or
11         heading - lastCam.heading| ≥ H_THRESHOLD or
12         speed - lastCam.speed| ≥ S_THRESHOLD then
13             cam = newCam(time, p, heading, speed)
14             sendCam(cam)
15             lastCam = cam
16             pHist = pHist ∪ p
17         else
18             p = lastPos
19             heading = lastHead
20         if time - lastCam.time ≥ T_THRESHOLD then
21             cam = newCam(time, p, heading, speed)
22             sendCam(cam)
23             lastCam = cam
24         System.wait(CHECK_PERIOD)
    
```

With the following triggering conditions:

D_THRESHOLD = 4 m
 H_THRESHOLD = +/- 4°,
 S_THRESHOLD = 0,5m/sec, and
 T_THRESHOLD = 1 sec
 CHECK_PERIOD = 0.1 sec

2.2.1 Example with triggering based on change of position

In this section, we review the example situation where new CAM generation is triggered only by a change in position. We assume driving at a steady speed and on a straight direction, so that the headings and acceleration/deceleration are not triggering factors. This situation may happen for instance when driving on a highway.

In this example, the speed of the ITS station has a direct impact on the CAM transmit rate, since as the car goes faster, the D_THRESHOLD is reached more rapidly. The Table 2-1 and Figure 2-2 show the relation between speed, equivalent time-interval between packets and equivalent transmit rate, for speeds of 0, 10, 20...160 km/h.

Table 2-1 ITS station speed, equivalent time-intervals & transmit rate

Speed [km/h]	Equivalent time-interval between packets [msec.]	Equivalent transmit rate [Hz]
0	1000	1.00
10	1000	1.00
20	720	1.39
30	480	2.08
40	360	2.78
50	288	3.47
60	240	4.17
70	206	4.86
80	180	5.56
90	160	6.25
100	144	6.94
110	131	7.64
120	120	8.33
130	111	9.03
140	103	9.72
150	100	10.00
160	100	10.00

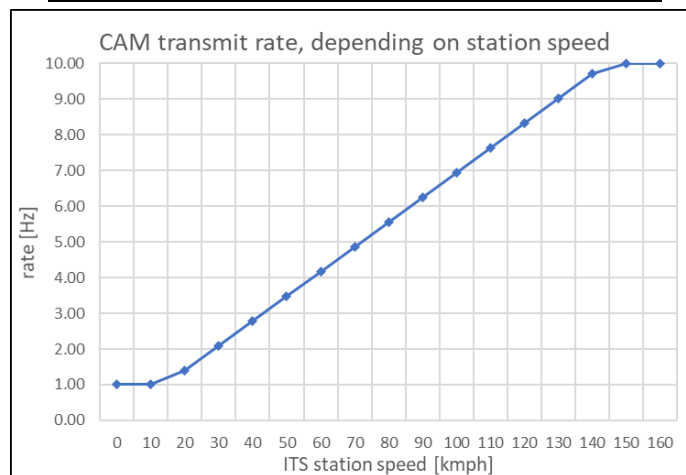

Figure 2-2 CAM transmit rate depending on ITS station speed

It can be observed that the transmit rates can be anywhere in the [1 Hz : 10 Hz] and that the time-intervals can be anywhere in the [100 msec. : 200 msec.] range.

In particular, we can see that no speed entry of the above table is leading to an integer transmit rate (in Hz), or an integer multiple of 100 msec. time-interval — except for the upper and lower bounds (≤ 10 km/h and > 140 km/h).

In practice, for all these intermediate speeds, the CAM time-intervals might not stay persistent, and would rather keep alternating between different values, for example alternating between 100 and 200 ms time-intervals, if the time granularity is 100 msec.

2.3 ITS-G5 stack: asynchronous messages

In this section, we discuss the overall ITS-G5 stack structure, and highlight its fundamentally asynchronous nature, and non-persistent message generation.

The Figure 2-3 depicts the ITS-G5 stack from a high-level view, showing the different layers: “Applications”, “Facilities”, “Network & Transport” and “Access technology”.

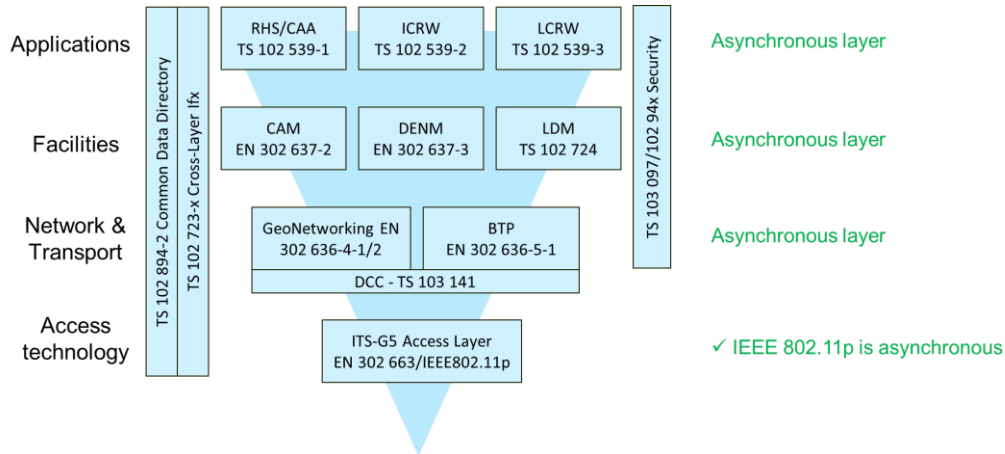

Figure 2-3 ITS-G5 stack view

The CAMs are generated at the Facilities level. As we have seen in previous section 2.2, the CAM messages are triggered by the drive dynamics, and as such are fundamentally asynchronous. The section 2.2.1 also highlighted that even at steady speeds the time-intervals will not be persistent.

The CAMs or DEMNs are encapsulated into GeoNetworking messages and transferred via BTP to the access layer, going through the Decentralized Congestion Control (DCC). The IEEE 802.11p Access layer technology is performing carrier sensing and running the channel access procedure for each message, unless the DCC layer holds the message.

The IEEE 802.11p Access layer technology is an asynchronous ad-hoc network, based on a “listen before talk” sensing mechanism. The medium access control (MAC) uses randomness in the backoff value selection, by drawing an integer backoff value from a uniform distribution [0, CW]. The backoff value is decremented by one when the channel is free during a slot time of 13 μs. When the backoff value reaches zero, the message is transmitted. When the channel gets busy during a slot time, the countdown is temporarily paused, but not resetted, and resumed after an arbitration inter frame space (AIFS) guard time. Several QoS levels define prioritization for emergency messages over the less important traffic.

Table 2-2 AIFS and CW sizes for 802.11p broadcast messages

AC	CW	AIFS
AC_VO	3	58 μs
AC_VI	7	71 μs
AC_BE	15	110 μs
AC_BK	15	149 μs

The IEEE 802.11p MAC channel access procedure ensures a fair and prioritized access to the channel. The asynchronous nature of this access layer ensure minimal footprint on the channel by avoiding systematic transmissions (for example via persistent reservations).

3 Theoretical CAM sizes variability

The following sections of the chapter will explore the CAM PDU variability due to the following blocks:

- Basic vehicle container: contains various optional fields
- Optional field: Low frequency container
 - Number of pathHistory is variable
- Optional field: Special vehicle container
- Certificates: present/not present

3.1 Optional containers

Optional containers as depicted in Figure 2-1 contain slowly changing data and are typically transmitted at a lower frequency, e.g. 1 Hz, in order to reduce data traffic.

The Low frequency container contains the following information: vehicle role (1 Byte), exterior lights status (1 Byte) and the pathHistory entries (multiple entries, 8 or 9 Bytes per entry).

The special vehicle container is used in special situations where information about the vehicle role is important and must be transmitted (public transport, rescue, dangerous goods etc.). Sizes of such container depend on the vehicle role.

3.2 Signatures and certificates

The certificates might be requested by the infrastructure equipment such as RSU, and/or be transmitted regularly (for instance at least once per second). Typical sizes of certificates and signatures are from 100 to 150 Bytes long.

Element	Value	Description	Length in octets
Certificate			
uint8 version	0x02		1
SignerInfo signer_info			
SignerInfoType type	0x01	certificate_digest_with_sha256	1
HashedId8 digest	[...]		8
SubjectInfo subject_info			
SubjectType type	0x01	authorization_ticket	1
opaque subject_name<var>	0x00	length: 0 → no name	1
[subject name]			0
SubjectAttribute subject_attributes<var>	0x2b	length: 43	1
SubjectAttributeType type	0x00	verification_key	1
PublicKey key			
PublicKeyAlgorithm algorithm	0x00	ecdsa_nistp256_with_sha256	1
EccPoint public_key			
EccPointType type	0x02	compressed_lsb_y_0	1
opaque x[32]	[...]		32
SubjectAttributeType type	0x02	assurance_level	1
SubjectAssurance assurance_level	0x83	level_4_confidence_3	1
SubjectAttributeType type	0x33	its_aid_ssp_list	1
ItsAidSsp its_aid_ssp_list<var>	0x04	length: 4 octets	1
IntX its_aid	[...]		1
opaque service_specific_permissions<var>	0x02	length: 2 octets	1
[service specific permissions]	[...]		2
ValidityRestriction validity_restrictions<var>	0x09	length: 9 octets	1
ValidityRestrictionType type	0x01	time_start_and_end	1
Time32 start_validity	[...]		4
Time32 end_validity	[...]		4
Signature signature			
PublicKeyAlgorithm algorithm	0x00	ecdsa_nistp256_with_sha256	1
EcdsaSignature ecdsa_signature			
EccPoint R			
EccPointType type	0x00	x_coordinate_only	1
opaque x[32]	[...]		32
opaque s[32]	[...]		32
The total size of this certificate is 132 octets.			

Figure 3-1 Example structure of a certificate (table A.2 of ETSI TS 103 097)

For further details on ITS-G5 certificates format and associated sizes, refer to [RD-5].

3.3 Number of pathHistory

The pathHistory provides a history of the latest movements over a given time or distance, facilitating e.g. path prediction. The number of pathHistory entries, called “pathPoint”, is dependent of the driving conditions, and possibly on the implementations. In particular for the “facilities” upper layer, different profiles exist. For instance the C2C_CC profile 1.3 [RD-2], the AUTOSAR CP Release 4.3.1 [RD-3] request that the pathHistory container should cover between 200 and 500 meters of history of the vehicle (requirements RS_BSP_285 and RS_BSP_286 from C2C_CC profile [RD-2], and requirements SWS_V2xFac_20285 and SWS_V2xFac_20286 from AUTOSAR CP [RD-3]). Some other profiles, like SCOOP release 1.2 of delivery 2.4.1 [RD-4] encourage larger number of pathHistory for usage of additional services such as advanced traffic management (up to 40 entries).

The size of pathHistory is therefore depending on parameters such as the trajectory and speed of the vehicle. We can expect that low-speed or urban type of situations will induce more pathHistory entries than highways type of situations.

Additionally, it should be noted that Facilities layer shall clear the own station’s path history cache when the security entity changes its pseudonym identity, which can happen every few minutes. In such situations, the number of pathHistory will then go down to zero, and grow again depending on the dynamics of drive. This behaviour is enforced by regulations in Europe, for citizen privacy reasons (avoiding capability to track a car for a long period of time).

4 Drive tests and traces captured

In this section a set of test drive results will be presented. The ITS devices used in these drives are commercial off-the-shelf devices. In order to represent the differences between implementations and parametrizations test drives from two manufacturers have been chosen.

The Table 4-1 lists the traces that have been collected for this survey.

Table 4-1 Traces collected for the CAM statistics survey

Trace name	Company providing trace	Type of drive environment	Location where trace was recorded	Standard	Facilities layer profile
"VW urban"	VW	Urban	Gifhorn, Germany	ETSI ITS-G5	C2C_CC profile 1.3
"VW suburban"	VW	Suburban	Gifhorn, Germany	ETSI ITS-G5	C2C_CC profile 1.3
"VW highway"	VW	Highway (slow)	Gifhorn, Germany	ETSI ITS-G5	C2C_CC profile 1.3
"Renault urban"	Renault	Urban	Vienna, Austria	ETSI ITS-G5	SCOOP 1.2, 2.4.1
"Renault suburban"	Renault	Suburban	Vienna, Austria	ETSI ITS-G5	SCOOP 1.2, 2.4.1
"Renault highway"	Renault	Highway	Vienna, Austria	ETSI ITS-G5	SCOOP 1.2, 2.4.1

The drive routes are depicted in the figures Figure 4-1 to Figure 4-6.

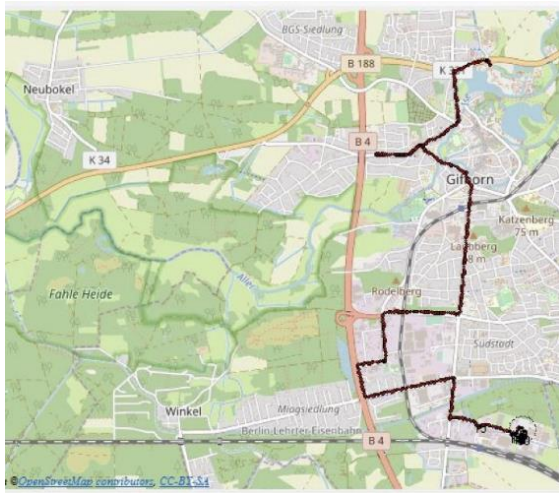

Figure 4-1 VW urban drive map



Figure 4-2 VW suburban drive map

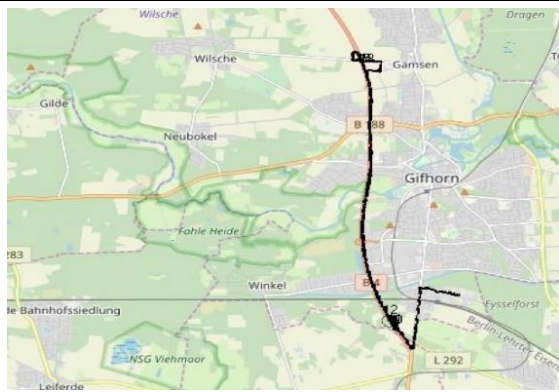

Figure 4-3 VW highway drive map



Figure 4-4 Renault highway drive map



Figure 4-5 Renault suburban drive map



Figure 4-6 Renault urban drive map

5 Methodology

The CAM traces have been read in appropriate tools, such as Wireshark®.

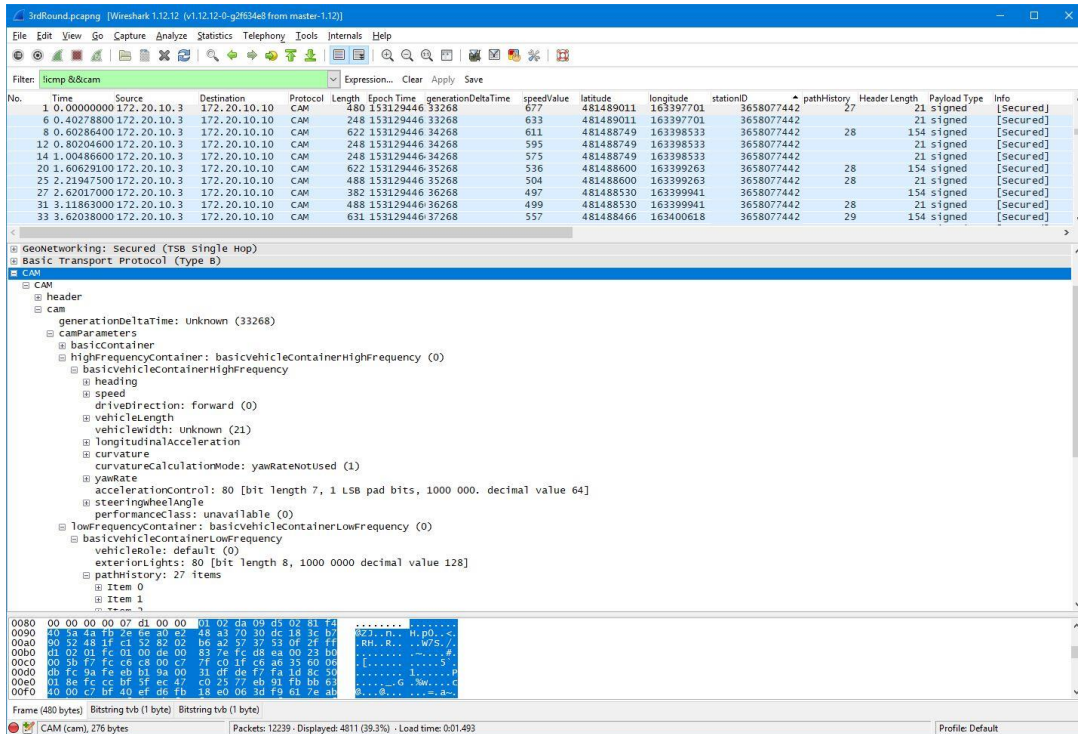

Figure 5-1 Wireshark tool example

The traces have been further post-processed for statistics in appropriate tools, such as Matlab®. The test drives have been analysed individually and are reported in the following section.

6 Results analysis

The CAM traces have been read in appropriate tools,

6.1 CAM sizes: variations versus time

Shown below are the CAM sizes plotted in chronologic order. Each graph depicts the CAM sizes from a single trace and a single car.

Observation #1: CAM size keeps changing from one message to the next, for all the drives.

The CAM sizes keep changing mainly due to optional containers, presence/absence of certificates, and varying depth of pathHistory.

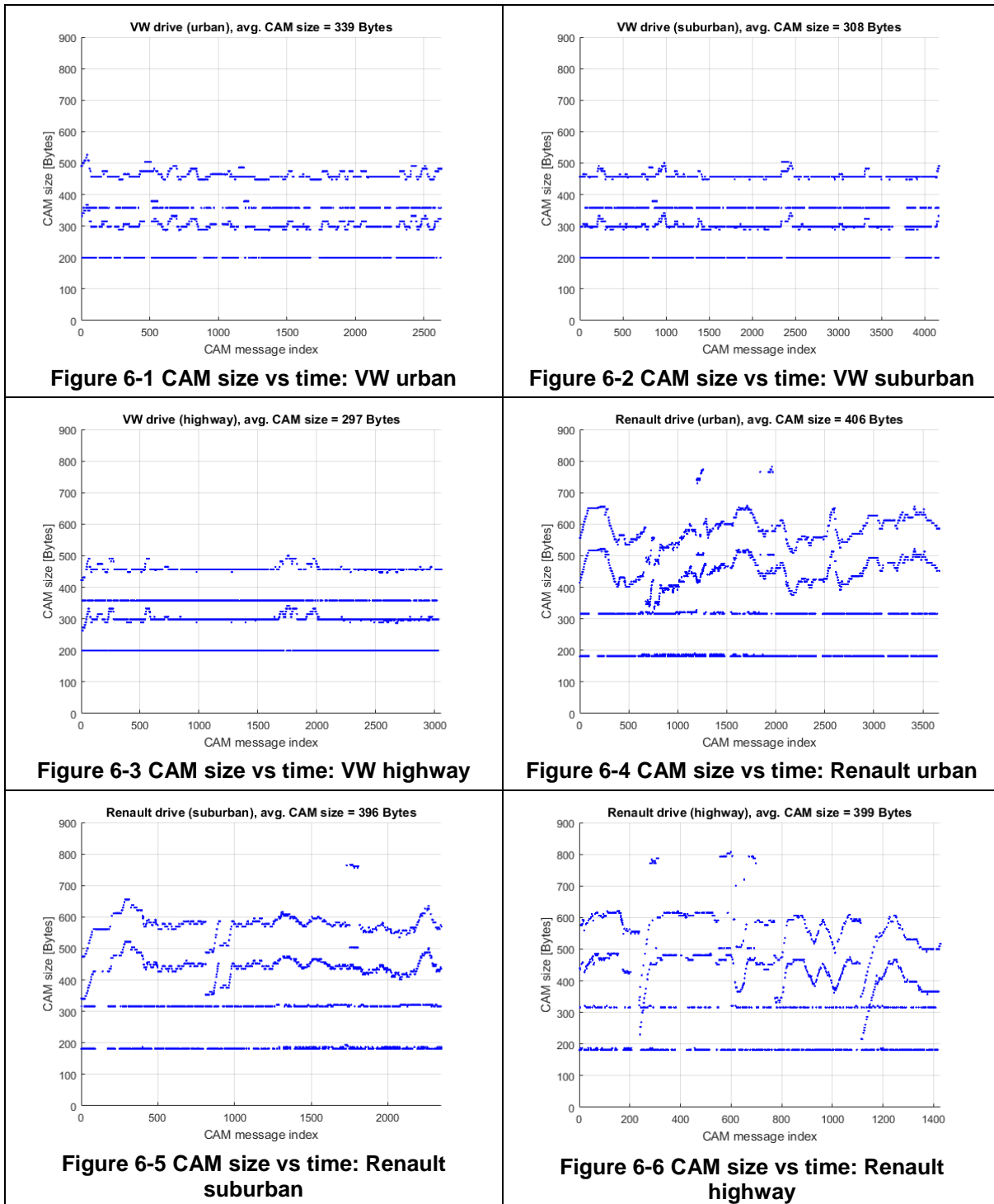

Even for the highway drives, which appear to have the fewer variations, we can see that the message size keeps varying. For example, in Figure 6-7 a zoom on one of the test drives, with the CAM size dots connected is depicted.

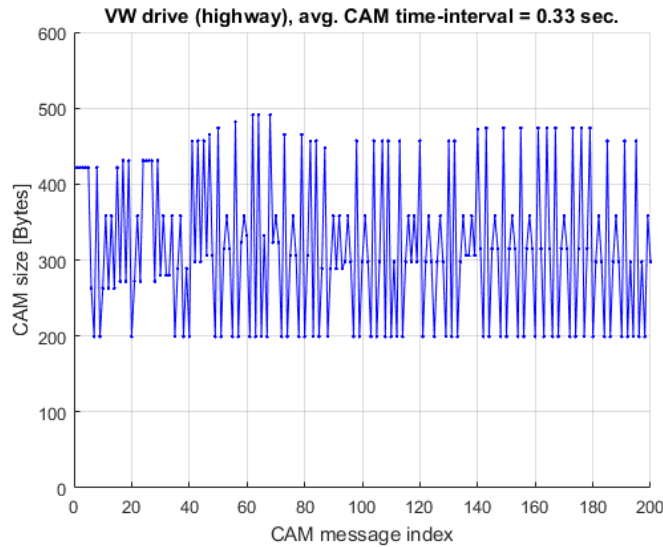

Figure 6-7 CAM size vs time: VW highway – zoom

6.2 CAM sizes: histograms distribution view

In this section we show the CAM sizes statistics occurrences, represented in shapes of histograms.

Observation #2: The set of possible CAM sizes is very diverse, for all test drives.

The CAM sizes can typically be separated into two groups:

- One group with very few variability, at around 200 Bytes, representing around 30% of the messages. Such messages have no certificates, no pathHistory. This group of CAMs is highlighted within green dotted lines.
- One group that is very diverse, ranging from 300 to 800 Bytes, representing around 70% of the messages. Such messages do have no certificates, and pathHistory variability. This group of CAMs is highlighted within red dotted lines.

We can also see that the histograms shapes variations seem to be coming more from the car maker / equipment rather than the type of drive, as represented in the summary figures below.

Observation #3: Significant differences in the upper part of the CAM distribution, per manufacturer or facilities layer profiles

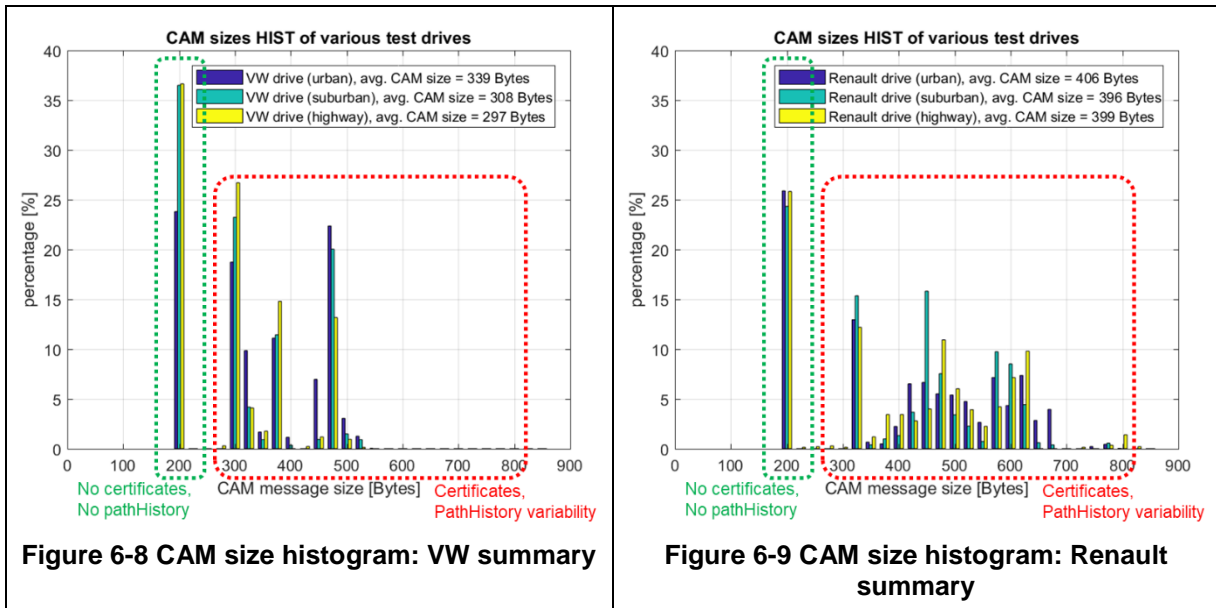

For reference, the per test-drive individual plots are available in the annex.

6.3 CAM: percentage of messages with certificates

In this section we measure the percentage of CAM that contain certificate.

Table 6-1 Percentage of message with certificates per test-drive

Trace	Percentage of CAM <u>without</u> certificates	Percentage of CAM <u>with</u> certificates
VW urban	23.8%	76.2%
VW suburban	36.5%	63.5%
VW highway	36.7%	63.3%
Renault urban	25.9%	74.1%
Renault suburban	24.3%	75.7%
Renault highway	26.2%	73.8%

Observation #4: Typically, only between 25% and 35% of the messages do not contain certificates.

6.4 CAM sizes: min, max and average statistics

In this section, the min, max and average values of the CAM are discussed. The below table summarizes such statistics for each test drive.

Table 6-2 Key CAM statistics for each test drive

Trace	CAM sizes, mean value	CAM sizes, min value	CAM sizes, max value
VW urban	339 Bytes	199 Bytes	526 Bytes
VW suburban	308 Bytes	199 Bytes	504 Bytes
VW highway	297 Bytes	199 Bytes	500 Bytes
Renault urban	406 Bytes	182 Bytes	782 Bytes
Renault suburban	396 Bytes	182 Bytes	765 Bytes
Renault highway	399 Bytes	182 Bytes	807 Bytes
Overall average	357 Bytes		

Observation #5: The average CAM sizes is typically around 350 Bytes, averaged over all test drives.

The minimum value is consistent around 200 Bytes, while the max value is rather diverse. The difference in minimum CAM size between manufacturers can be explained by differently configured use of optional fields in the Basic Container and different facilities layer profiles.

6.5 CAM sizes: CDF distributions

In this section the CAM sizes statistics occurrences, represented in shapes of CDF (Cumulative Distribution Function) are represented.

Observation #6: The approximate CAM size distributions can be observed:

- **Distribution starts around 190 Bytes**
- **Typically, 30% of the messages are below 300 Bytes**
- **Typically, more than 50% of the messages are above 350 Bytes**
- **Typically, more than 30% of the messages are above 450 Bytes**

It can also be seen that the shapes variations seem to be coming more from the car maker / equipment rather than the type of drive, as represented in the summary figures below.

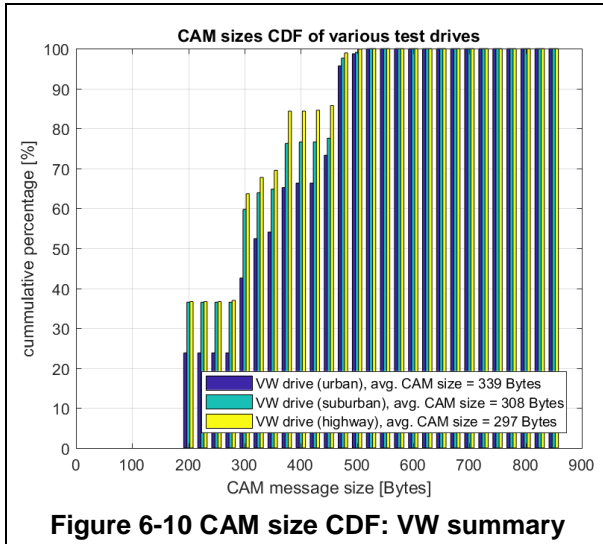

Figure 6-10 CAM size CDF: VW summary

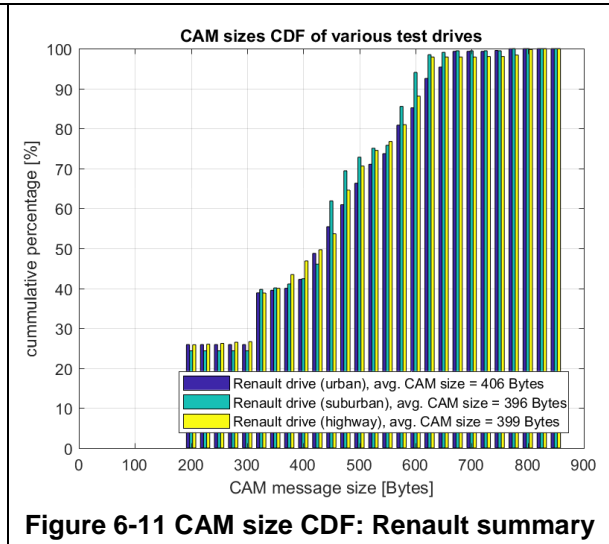

Figure 6-11 CAM size CDF: Renault summary

6.6 CAM sizes: pathHistory detailed statistics

As explained in previous section, the number of pathHistory entries has a strong impact on the overall CAM size. In this section, we analyse how the number of pathHistory entries is correlated with the speed and trajectory history of the vehicle.

In Figure 6-12, we have used the Renault urban test drive, since it is the test drive showing the most speed variability. We have isolated the section where the driver performed a U-turn, with interesting deceleration and acceleration phases.

Note: for this exercise, only the CAM with pathHistory and speed entries have been used. The CAM which did not convey such optional fields have been filtered out for readability of the plots in Figure 6-12.

On the left subplot, the number of pathHistory entries and speed are plotted against time. The middle subplot shows the distribution of the number of pathHistory entries against speed. The rightmost subplot shows the drive considered.

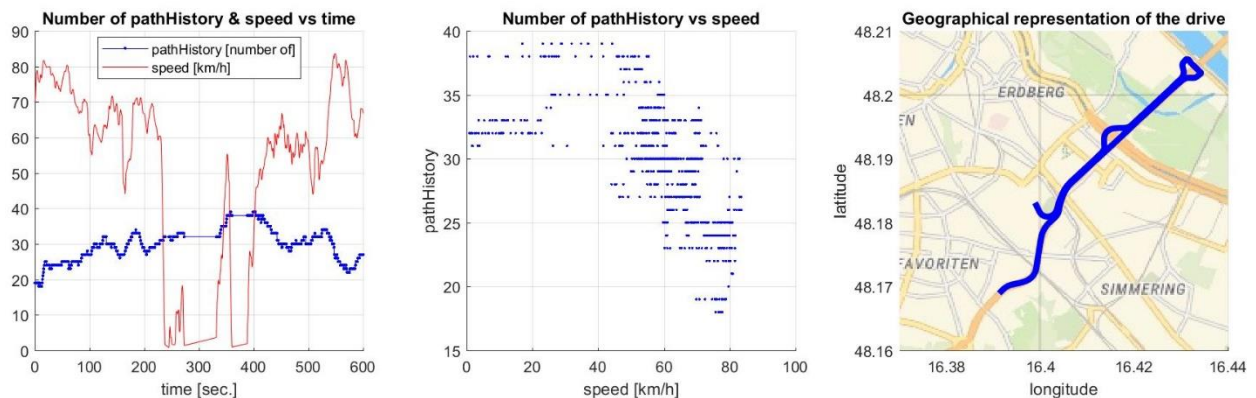

Figure 6-12 Study on correlation of pathHistory and speed

In the middle subplot, we can see a clear correlation between Speed and number of pathHistory entries.

Observation #7: Speed and number of pathHistory entries are heavily correlated.

In the next picture, we show the evolution of the number of the pathHistory entries for the different Renault drives.

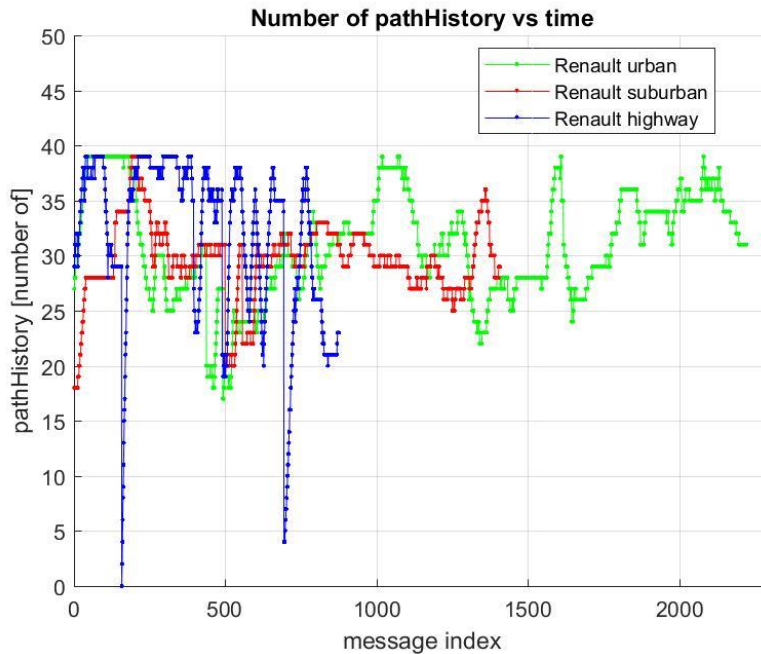

Figure 6-13 number of pathHistory entries for Renault drives

The associated pathHistory statistics have been summarized in the below table:

Table 6-3 Number of pathHistory entries per test-drive

Trace	pathHistory entries, mean value	pathHistory entries, min value	pathHistory entries, max value
Renault urban	30.9	17	39
Renault suburban	29.6	18	39
Renault highway	31.7	0	39

The average number of pathHistory entries was around 30, and can be as large as 39, for the test-drives and profile considered.

Note: this section will be updated in the future as we collect more traces, potentially using different equipment and different Facilities layer profiles.

6.7 CAM time-intervals: variations vs time

In this section are represented the CAM time-intervals, which is the time delta between the generation of two consecutive messages.

According to the message generation rules explained in the above sections, several conditions can trigger the generation of the messages (i.e. speed, steering, and change of acceleration, special vehicle or special vehicle condition). Theoretically, the generation of the messages can happen at any time. However, in the traces collected we see a granularity of 100ms, which can be explained by the GPS clock stamping refresh rate or the POTI injection clock rate. Therefore, it might be that in reality the CAM time-intervals have a finer time granularity than depicted in the plots below. However, the observations cited thereafter will remain valid. Also, there are few outliers for which observe a time-interval delta larger than 1 second. This could be the consequence of traces collection inaccuracies, or ITS-G5 channel being busy by other messages (the Renault drive tests were recorded with several cars following each other), or by lack of GPS fix.

Observation #8: In practice, the CAM time-interval very often changes from one message to the next, observed in all the drives.

In most cases, the CAM time-interval does not stay constant. In a few cases one or a maximum of two intervals are constant.

Some particular situations may lead to a long and persistent CAM time-interval, such as standing still (plateau at time-interval = 1 sec, for example at a traffic light), or a driving on a straight road at exactly constant speed. The VW urban drive exhibits these two situations as depicted in Figure 6-14 and more in detail in Figure 6-21.

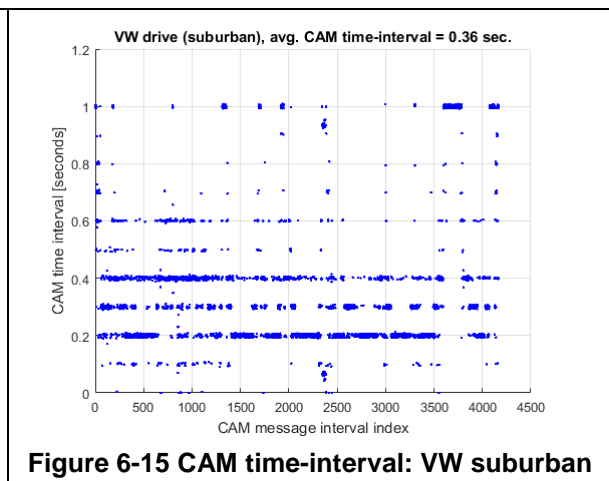
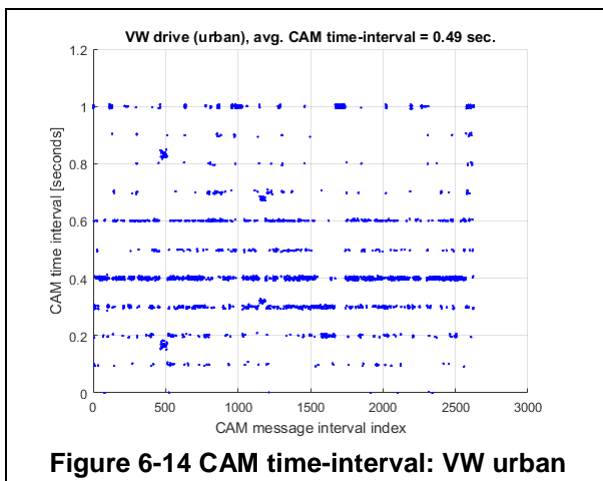

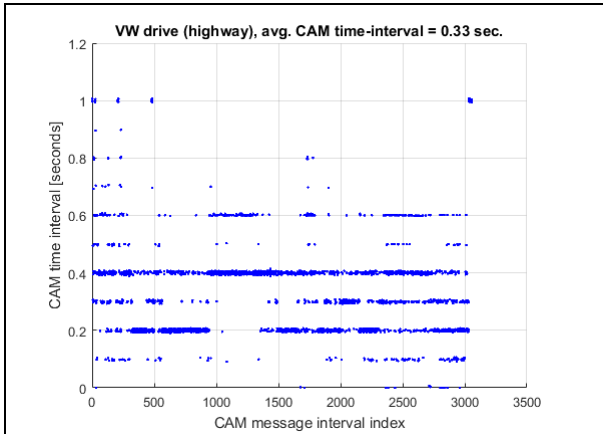

Figure 6-16 CAM time-interval: VW highway

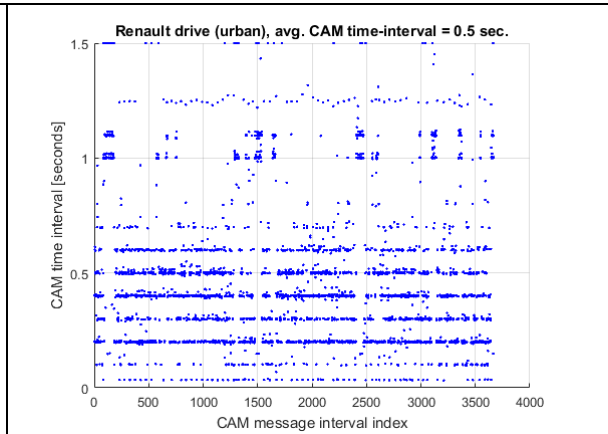

Figure 6-17 CAM time-interval: Renault urban

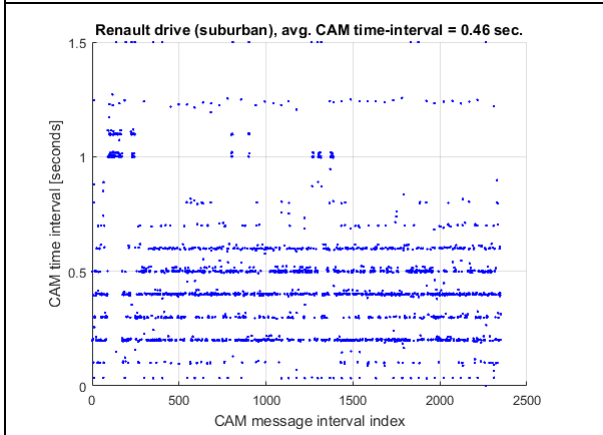

Figure 6-18 CAM time-interval: Renault suburban

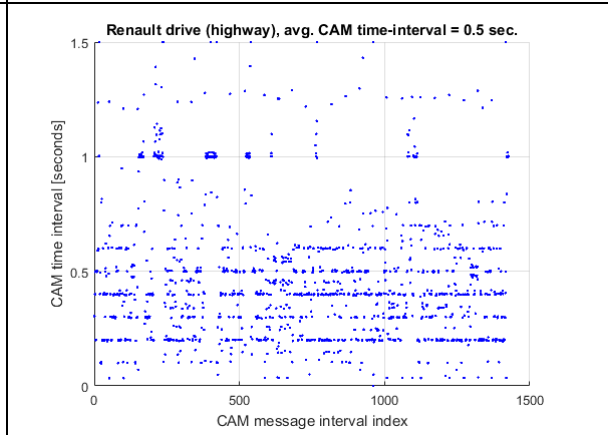

Figure 6-19 CAM time-interval: Renault highway

Hereafter is a zoom on one of the test drives (VW highway), with the CAM time-interval dots connected, showing the general situation with very few persistency:

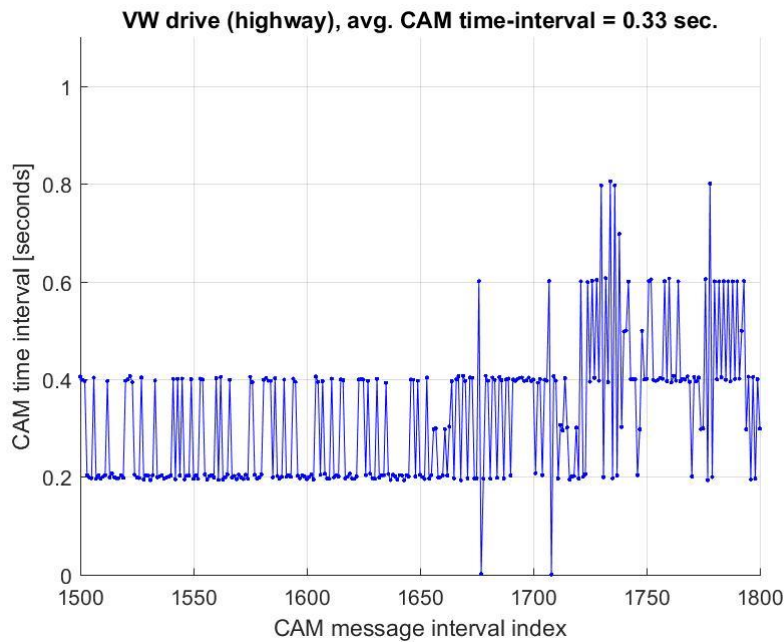

Figure 6-20 CAM time-interval: VW highway, zoom

In Figure 6-21 a zoom on one of the test drives (VW urban) is depicted, with the CAM time-interval dots connected, showing 4 plateau regions. The CAM size is also plotted on the vertical axis.

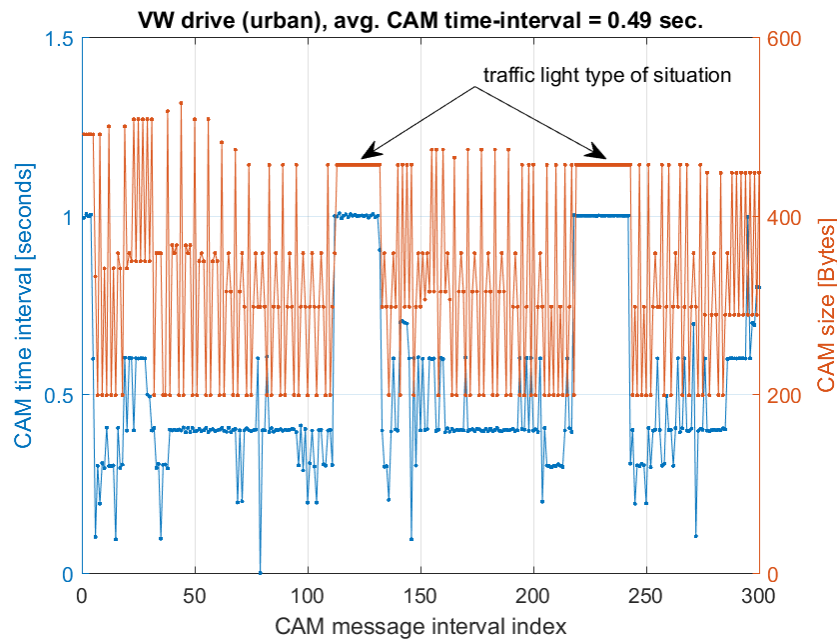

Figure 6-21 CAM time-interval: VW urban, zoom

We can see two plateaus of constant 1.0 sec. time-intervals, around message indices 120 and 220. The CAM size curve also marks a plateau at the exact same time. Such events have been highlighted in Figure 6-21 as “traffic light type of situations”.

We can also see two plateaus of constant 0.4 sec. time-intervals around message indices 50 and 170, but in contrast to the 1.0 sec. time-intervals plateaus, the CAM size is not steady at all in these conditions. Such situations can occur when driving at constant speed.

6.8 CAM time-intervals: histograms distribution view

In this section we analyse the distribution of the time-intervals. A granularity of 0.1 second has been used for the histograms bins’ widths, but other intervals (finer intervals) would also be a valid option. Also, the average value of the time-intervals has been computed.

We can see that the CAM time-interval distributions are rather diverse, from one scenario to the other. Some scenarios exhibit significant peaks, such as the 0.4 seconds bin in the VW urban scenario, or the 0.2 seconds bin the VW suburban scenario. This may be explainable by the rather straight route and the speed limitations (0.2 and 0.4 seconds would correspond to 36 km/h and 70km/h respectively, if CAM is triggered only by change of location).

Observation #9: The distribution of the CAM time-interval is very diverse, and heavily depend on the drive scenario.

Observation #10: The average values of the time-intervals vary between 0.33 and 0.47 seconds.

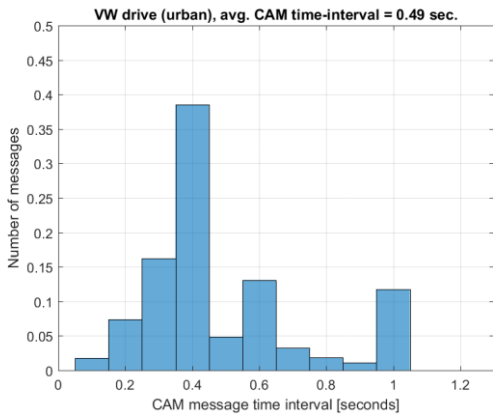

Figure 6-22 CAM time-interval histogram: VW urban

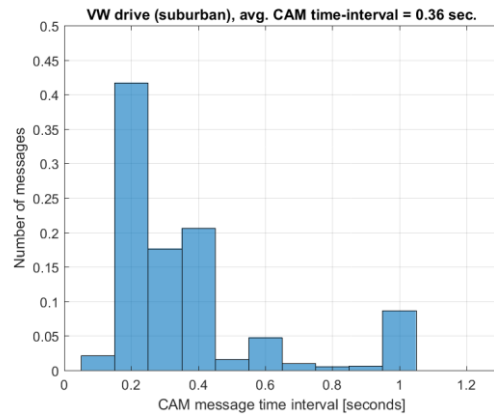

Figure 6-23 CAM time-interval histogram: VW suburban

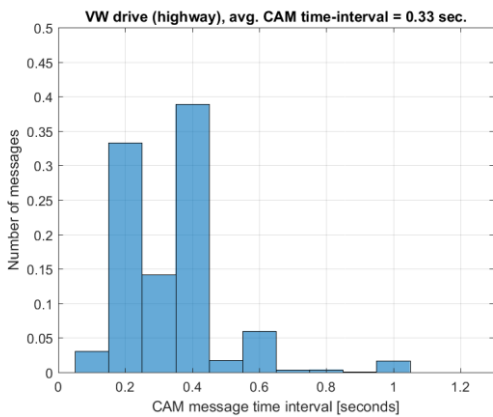

Figure 6-24 CAM time-interval histogram: VW highway

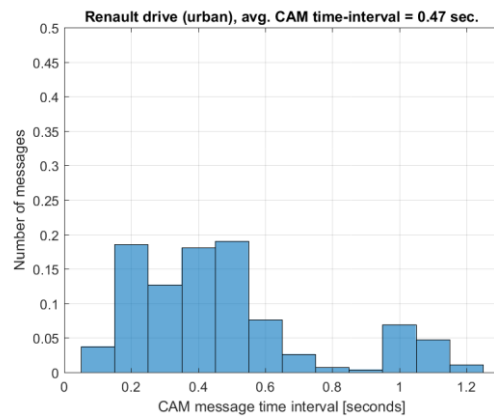

Figure 6-25 CAM time-interval histogram: Renault urban

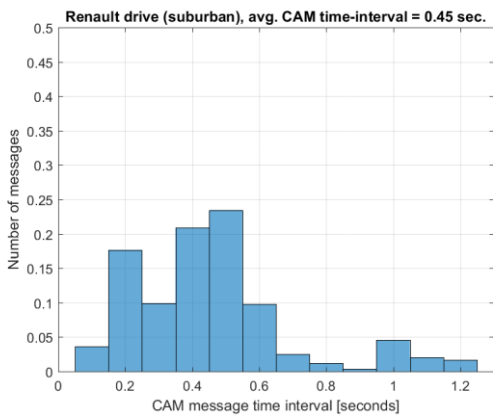

Figure 6-26 CAM time-interval histogram: Renault suburban

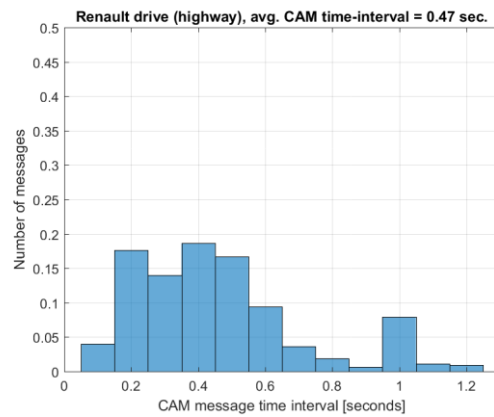
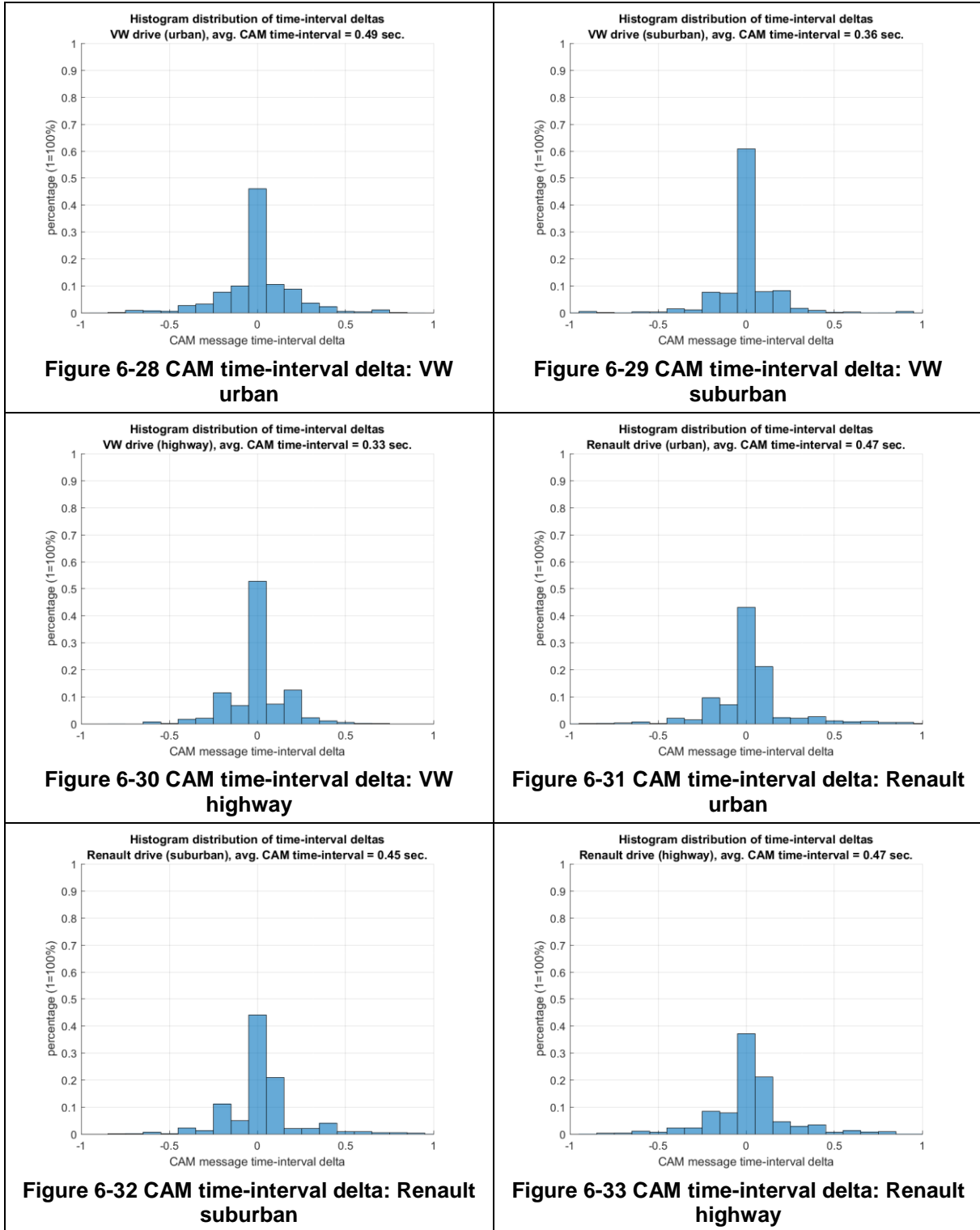

Figure 6-27 CAM time-interval histogram: Renault highway

6.9 CAM time-intervals delta: histograms distribution view

In this section we analyse the distribution of the time-intervals delta. Time-intervals delta is the difference between two consecutive time-intervals. If the delta is zero, it means that the time-interval stayed constant from one message to the next.

Observation #11: In average, roughly only 50% of the time-interval deltas is zero (meaning only one every 2 samples has the same time-interval as the previous message, in average)



6.10CAM: duty cycles results

In this section we compute and discuss the duty cycle requirements and measurements.

The harmonised standard EN 302 571 [RD-6] defines the duty cycle as being the ratio, expressed as a percentage of the transmitter total "on" time on one carrier frequency, **relative to 1 second period, and sets a limit of 3%.**

On top of this, additional regional regulations might enforce stronger requirements, sometimes in certain situations such as road tolling neighbourhood. For example, the ECC report 228 [RD-7] defines a **maximum duty cycle of 1% in one hour with a peak duty cycle of maximum 2% in one second.**

The peak short-term duty cycles measured over 1 second are meant to secure a headroom for DENM, which are transmitted in case of temporary traffic incidents or emergency, in addition to the regular CAM messages. Therefore, it is essential to verify that the traffic load originating from CAM is not compromising this headroom. As an approximation, we can target that the traffic due to CAM is not exceeding half of the authorized peak short-term duty cycle.

The following Table 6-4 summarises the duty cycle requirements to be verified.

Table 6-4 ECC duty cycle requirements

Requirement	Spec	Duty cycle limit	Measurement duration	Messages considered	Measurement name
Requirement #1	EN 302 571	3%	1 second	CAM + DENM	Short-term duty cycle
Requirement #1b		1.5%	1 second	CAM	Short-term duty cycle
Requirement #2	ECC report 228	1%	1 hour(*)	CAM + DENM	Long-term duty cycle
Requirement #3	ECC report 228	2%	1 second	CAM + DENM	Short-term duty cycle
Requirement #3b		1%	1 second	CAM	Short-term duty cycle

The Table 6-5 below summarises the measured duty cycles for the different test drives. The figures Figure 6-34 to Figure 6-39 show the short-term duty cycle for all the test drives.

(*) The test drives recorded have a duration shorter than 1 hour. The reported duty cycle is therefore computed over the duration of the test drive.

Table 6-5 Measured duty cycles for each test drive

Trace	Total duration of all packets	Duration of test drive	Long-term duty cycle	Max peak short-term duty cycle (1 sec. meas.)
VW urban	1.33 sec.	~21 min.	0.10%	0.26%
VW suburban	1.94 sec.	~25 min.	0.13%	0.29%
VW highway	1.37 sec.	~27 min.	0.13%	0.27%
Renault urban	2.18 sec.	~30 min.	0.12%	0.40%
Renault suburban	1.37 sec.	~18 min.	0.13%	0.41%
Renault highway	0.84 sec.	~12 min.	0.12%	0.39%

Observation #12: The long-term duty cycles are consistently measured between 0.10% and 0.13%, for all test drives. This is compliant with the requirement of long-term duty cycle of max. 1%, by a comfortable margin.

Observation #13: The short-term (1-second) duty cycles peaks are measured between 0.26% and 0.41%, depending on the test drives. This is compliant with the requirement of CAM-induced 1 second short-term duty cycle of max. 1% or 1.5%, by a comfortable margin.

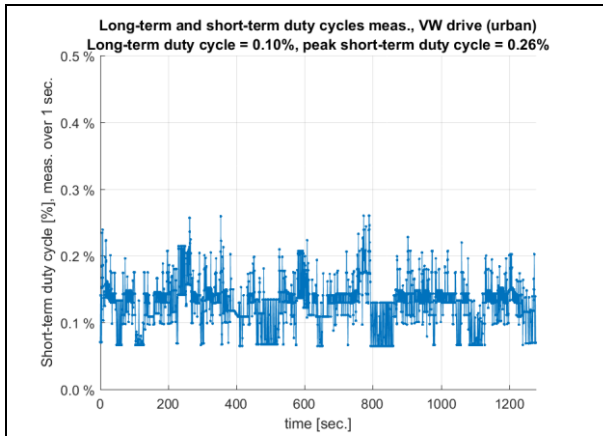

Figure 6-34 CAM duty cycles: VW urban

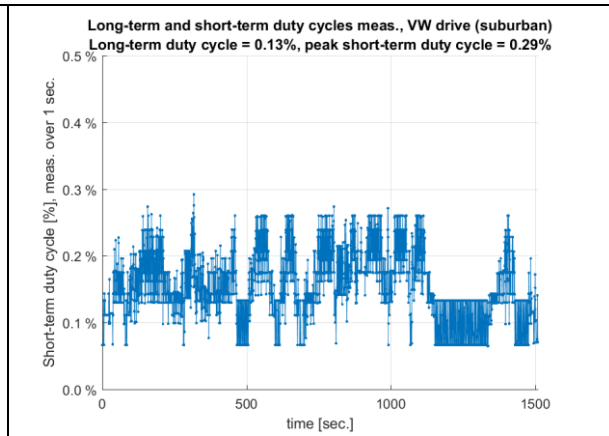

Figure 6-35 CAM duty cycles: VW suburban

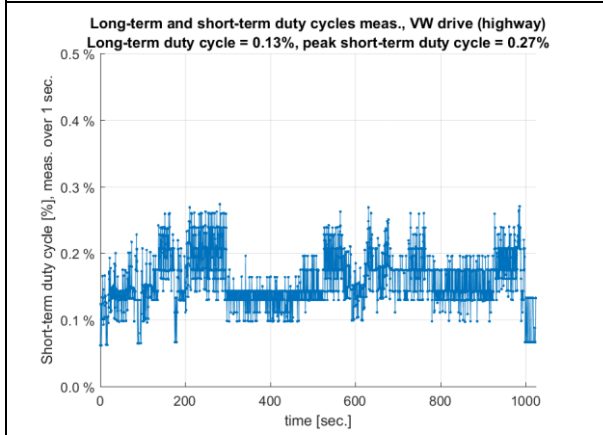

Figure 6-36 CAM duty cycles: VW highway

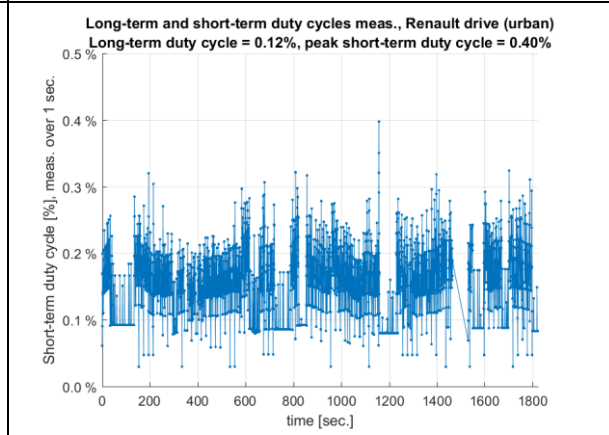

Figure 6-37 CAM duty cycles: Renault urban

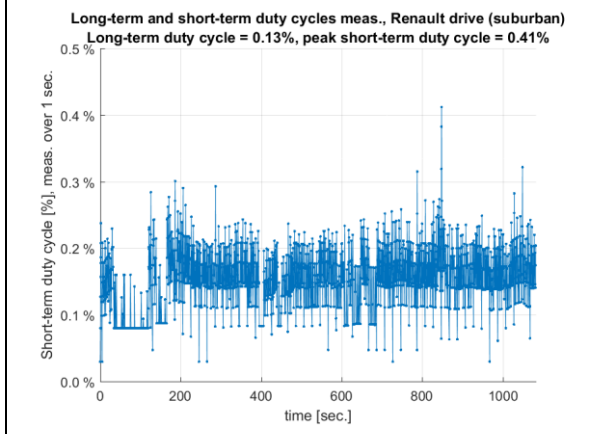

Figure 6-38 CAM duty cycles: Renault suburban

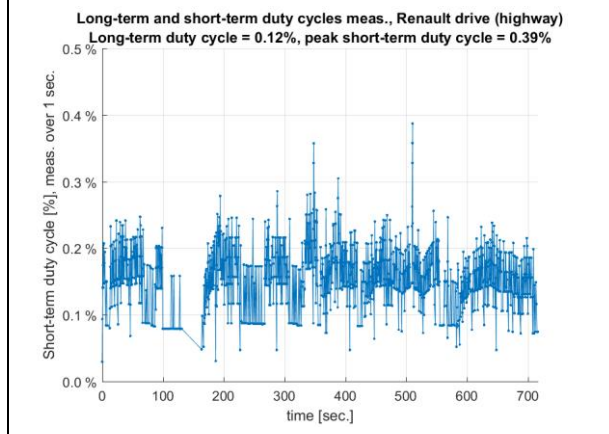

Figure 6-39 CAM duty cycles: Renault highway

7 Conclusions

In this document, results from real test drives have been presented. They highlight the very diverse and non-persistent nature of the CAM messages, both from a size and a transmit rate perspective. They fluctuate in a way that is not possible to predict.

Some key statistics have been extracted from the traces used in the present survey:

- The average CAM sizes is typically around 350 Bytes
- The approximate CAM size distributions can be observed:
 - Distribution starts around 190 Bytes
 - Typically, 30% of the messages are below 300 Bytes
 - Typically, more than 50% of the messages are above 350 Bytes
 - Typically, more than 30% of the messages are above 450 Bytes
- The average values of the time-intervals vary between 0.33 and 0.47 seconds.
- The long-term duty cycles are consistently measured between 0.10% and 0.13%, way below the 1% regulatory limit
- The short-term (1-second) duty cycles peaks are measured between 0.26% and 0.41%, way below regulatory limits

8 Appendix 1 – References

8.1 List of abbreviations

ACC	Adaptive Cruise Control
ADAS	Advanced Driver Assistant System
AIFS	Arbitration Inter Frame Space
BSM	Basic Safety Message
CAM	Cooperative Awareness Message
CDF	Cumulative Distribution Function
COM	Communication
DCC	Decentralized Congestion Control
DENM	Decentralized Environmental Notification Message
EC	European Commission
EDAS	EGNOS Data Access System
EGNOS	European Geostationary Navigation Overlay Service
ESA	European Space Agency
ESP	Elektronic Stability Programme
EU	European Union
FCD	Floating Car Data
FhG	Fraunhofer Gesellschaft
GLONASS	Globalnaya Navigatsionnaya Sputnikovaya Sistema
GNSS	Global Navigation Satellite System
GPRS	General Packet Radio System
GPS	Global Positioning System
GSM	Global System for Mobile Communications
GUI	Graphical User Interface
HMI	Human Machine Interface
ITS	Intelligent Transport System
ITS-G5	ITS broadcast technology based on an evolution of the wireless standard 802.11p
LBS	Location Based Services
MAC	Medium Access Control
MAP	Map Data
OEM	Original Equipment Manufacturer
PDA	Personal Digital Assistant
PDU	Packet Data Unit
POTI	(Facility) Position and Time management
RSU	Road Side Unit
SPAT	Signal Phase and Time
UMTS	Universal Mobile Telecommunications System
WLAN	Wireless Local Area Network

8.2 Related documents

- [RD-1] ETSI EN 302 637-2, “Intelligent Transport Systems (ITS); Vehicular Communications; Basic Set of Applications; Part 2: Specification of Cooperative Awareness Basic Service”
- [RD-2] C2C profile 1.3.0, Available at: <https://groupware.car-2-car.org/groupware/mydms/out/out.ViewFolder.php?menuaction=dummy&folderid=2218>.
- [RD-3] AUTOSAR CP Release 4.3.1 Specification of Vehicle-2-X Facilities. Available at: https://www.autosar.org/fileadmin/user_upload/standards/classic/4-3/AUTOSAR_SWS_V2XFacilities.pdf
- [RD-4] SCOOP release 1.2 of delivery 2.4.1. Available at: <http://www.scoop.developpement-durable.gouv.fr/specifications-techniques-a22.html>.
- [RD-5] ETSI TS 103 097, “Intelligent Transport Systems (ITS); Security; Security header and certificate formats”
- [RD-6] ETSI EN 302 571, “Intelligent Transport Systems (ITS); Radiocommunications equipment operating in the 5 855 MHz to 5 925 MHz frequency band; Harmonised Standard covering the essential requirements of article 3.2 of the Directive 2014/53/EU”
- [RD-7] ECC report 228, “COMPATIBILITY STUDIES BETWEEN INTELLIGENT TRANSPORT SYSTEMS (ITS) IN THE BAND 5855– 5925 MHz AND OTHER SYSTEMS IN ADJACENT BANDS”

8.3 CAM size histograms for each test drive

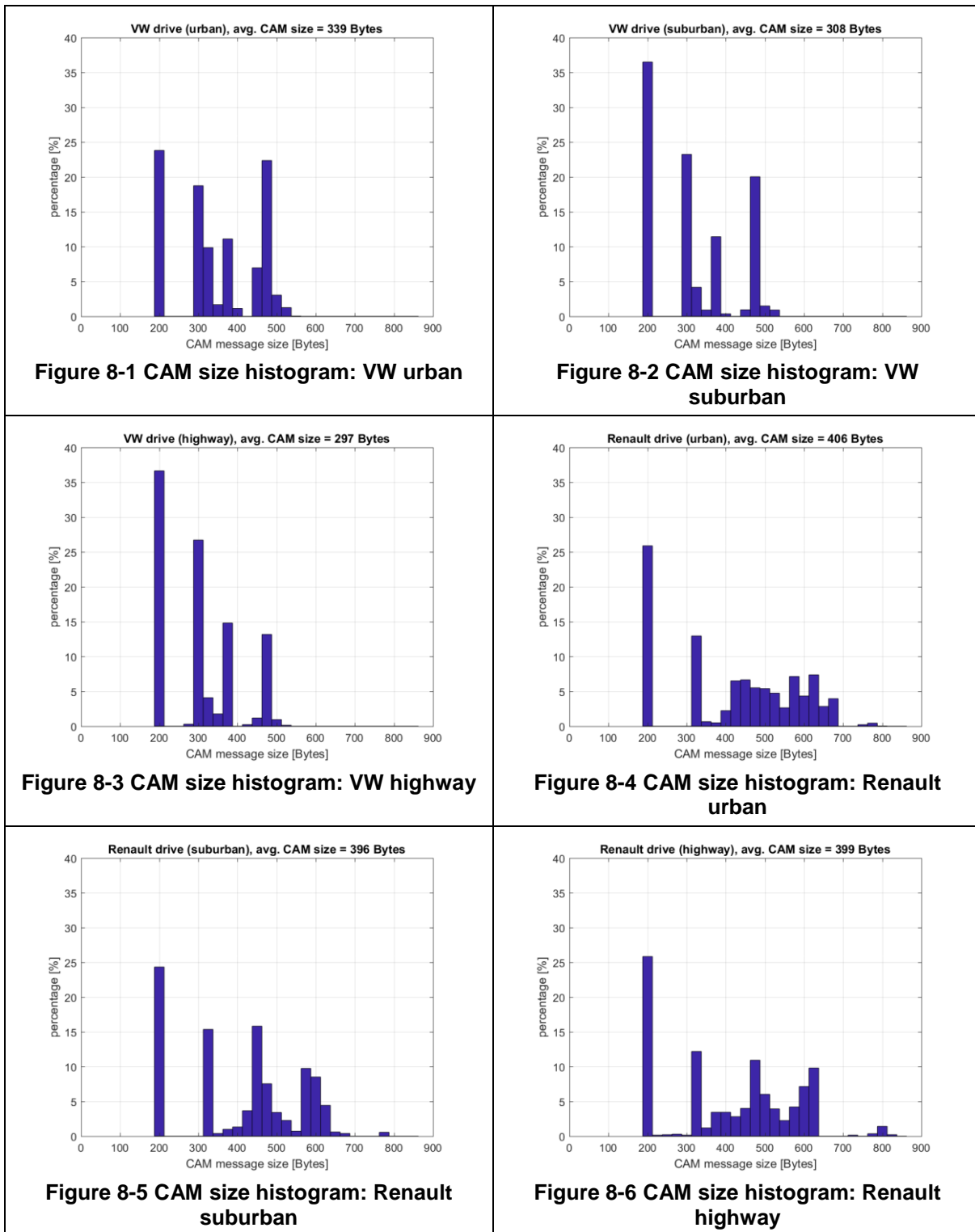

8.4 Acknowledgments

CAR 2 CAR Communication Consortium would like to thank the companies who participated in this survey for sharing their CAM traces (VW, Renault).

■ End of Document ■